

### Description

The AR0511P1LV is a bi-directional TVS diode, utilizing leading monolithic silicon technology to provide fast response time and low ESD clamping voltage, making this device an ideal solution for protecting voltage sensitive high-speed data lines. The AR0511P1LV has an ultra-low capacitance with a typical value at 0.15pF, and complies with the IEC 61000-4-2 (ESD) with  $\pm 20\text{kV}$  air and  $\pm 20\text{kV}$  contact discharge. It is assembled into an ultra-small 1.0x0.6x0.5mm lead-free DFN package. The small size, ultra-low capacitance and high ESD surge protection make AR0511P1LV an ideal choice to protect cell phone, digital video interfaces and other high speed ports.

### Features

- Ultra low capacitance: 0.15pF typical
- Ultra low leakage: nA level
- Operating voltage: 5V
- Low clamping voltage
- Complies with following standards:
  - IEC 61000-4-2 (ESD) immunity test
    - Air discharge:  $\pm 20\text{kV}$
    - Contact discharge:  $\pm 20\text{kV}$
  - IEC61000-4-5 (Lightning) 3A (8/20 $\mu\text{s}$ )
- RoHS Compliant

### Mechanical Characteristics

- Package: DFN1006-2 (1.0x0.6x0.5mm)
- Case Material: “Green” Molding Compound.
- Terminal Connections: See Diagram Below
- Marking Information: See Below

### Applications

- Cellular Handsets and Accessories
- Display Ports
- MDDI Ports
- USB Ports
- Digital Visual Interface (DVI)
- PCI Express and Serial SATA Ports

### Marking Information



### Dimensions and Pin Configuration

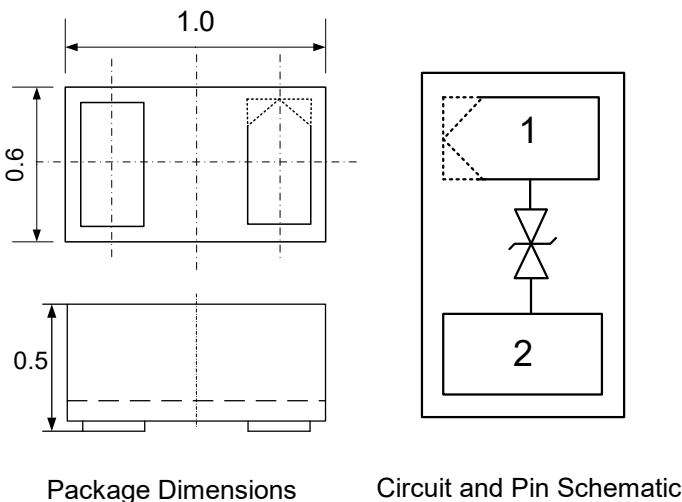

### Ordering Information

Part Number	Packaging	Reel Size
AR0511P1LV	10000/Tape & Reel	7 inch

**Absolute Maximum Ratings (T<sub>A</sub>=25°C unless otherwise specified)**

Parameter	Symbol	Value	Unit
Peak Pulse Power (8/20μs)	Ppk	45	W
Peak Pulse Current (8/20μs)	I <sub>PP</sub>	3	A
ESD per IEC 61000-4-2 (Air) ESD per IEC 61000-4-2 (Contact)	V <sub>ESD</sub>	±20 ±20	kV
Operating Temperature Range	T <sub>J</sub>	-55 to +125	°C
Storage Temperature Range	T <sub>stg</sub>	-55 to +150	°C

**Electrical Characteristics (T<sub>A</sub>=25°C unless otherwise specified)**

Parameter	Symbol	Min	Typ	Max	Unit	Test Condition
Reverse Working Voltage	V <sub>RWM</sub>			5	V	
Breakdown Voltage	V <sub>BR</sub>	6			V	I <sub>T</sub> = 1mA
Reverse Leakage Current	I <sub>R</sub>			0.2	μA	V <sub>RWM</sub> = 5V
Clamping Voltage	V <sub>C</sub>			11	V	I <sub>PP</sub> = 1A (8 x 20μs pulse)
Clamping Voltage	V <sub>C</sub>			15	V	I <sub>PP</sub> = 3A (8 x 20μs pulse)
Junction Capacitance	C <sub>J</sub>		0.15	0.25	pF	V <sub>R</sub> = 0V, f = 1MHz
			0.13		pF	V <sub>R</sub> = 0V, f = 2.5GHz

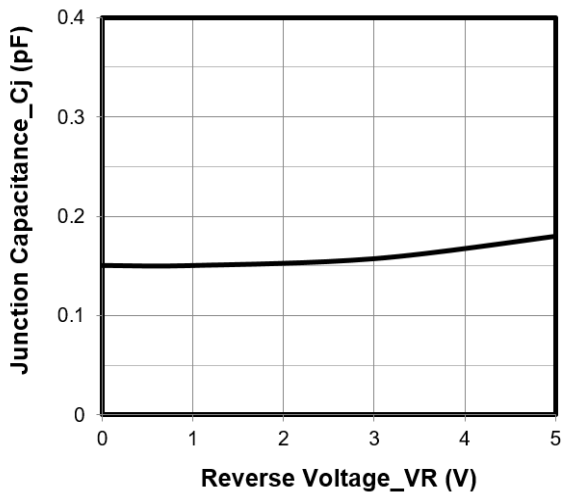
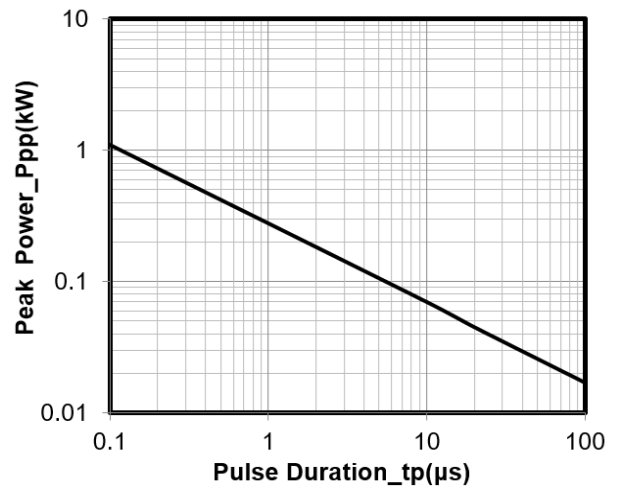
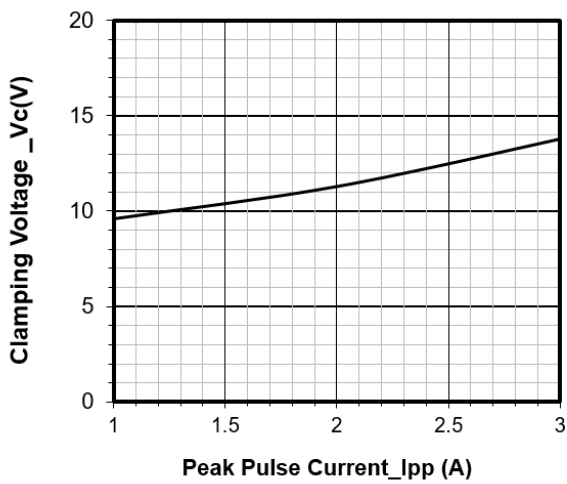
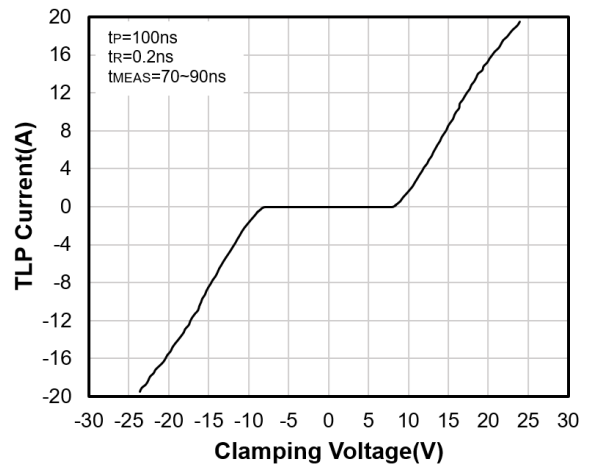
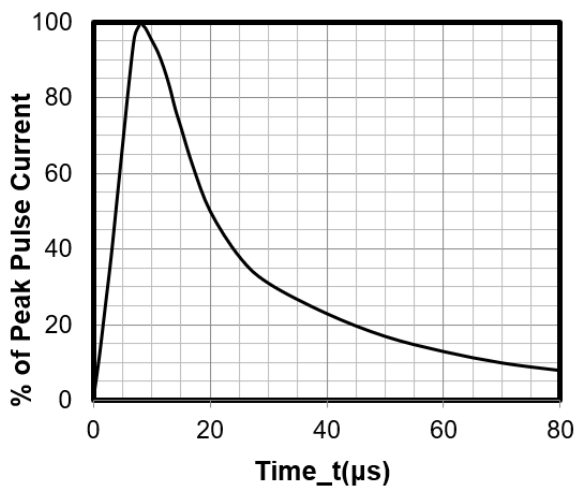
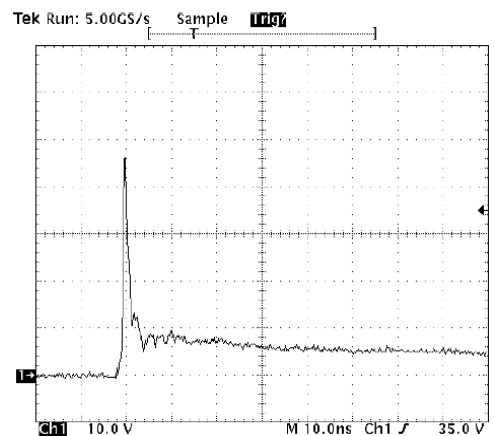
**Typical Performance Characteristics (TA=25°C unless otherwise Specified)**

**Junction Capacitance vs. Reverse Voltage**

**Peak Pulse Power vs. Pulse Time**

**Clamping Voltage vs. Peak Pulse Current**

**TLP Curve**

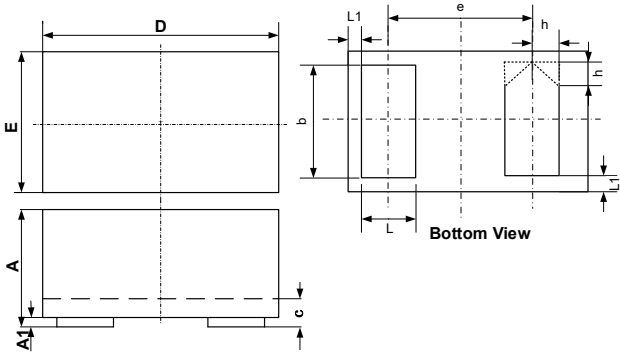
**8 X 20μs Pulse Waveform**

Note: Data is taken with a 10x attenuator

**ESD Clamping Voltage**

**8 kV Contact per IEC61000-4-2**

### DFN1006-2 Package Outline Drawing



SYM	DIMENSIONS					
	MILLIMETERS			INCHES		
	MIN	NOM	MAX	MIN	NOM	MAX
A	0.45	0.50	0.55	0.018	0.020	0.022
A1	0.00	0.02	0.05	0.000	0.001	0.002
b	0.45	0.50	0.55	0.018	0.020	0.022
c	0.12	0.15	0.18	0.005	0.006	0.007
D	0.95	1.00	1.05	0.037	0.039	0.041
e	0.65 BSC			0.026 BSC		
E	0.55	0.60	0.65	0.022	0.024	0.026
L	0.20	0.25	0.30	0.008	0.010	0.012
L1	0.05REF			0.002REF		
h	0.07	0.12	0.17	0.003	0.005	0.007

### Suggested Land Pattern

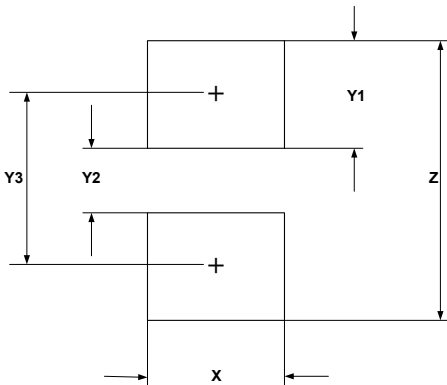

SYM	DIMENSIONS	
	MILLIMETERS	INCHES
X	0.60	0.024
Y1	0.50	0.020
Y2	0.30	0.012
Y3	0.80	0.032
Z	1.30	0.052