

Description

The AU0571P6H is an uni-directional TVS diode, utilizing leading monolithic silicon technology to provide fast response time and low ESD clamping voltage, making this device an ideal solution for protecting voltage sensitive data and power line. The AU0571P6H complies with the IEC 61000-4-2 (ESD) standard with $\pm 30\text{kV}$ air and $\pm 30\text{kV}$ contact discharge. It is assembled into an ultra-small 1.0x0.6x0.5mm lead-free DFN package. The small size and high ESD surge protection make AU0571P6H an ideal choice to protect cell phone, digital cameras, audio players and many other portable applications.

Features

- Protects one data or power line
- Ultra low leakage: nA level
- Low operating voltage: 5V
- Low clamping voltage
- 2-Pin leadless package
- Complies with following standards:
 - IEC 61000-4-2 (ESD) immunity test
 - Air discharge: $\pm 30\text{kV}$
 - Contact discharge: $\pm 30\text{kV}$
 - IEC61000-4-5 (Lightning) 160A (8/20 μs)
- RoHS Compliant

Mechanical Characteristics

- Package: DFN1610-2
- Case Material: “Green” Molding Compound.
- Terminal Connections: See Diagram Below
- Marking Information: See Below

Applications

- Cellular Handsets and Accessories
- Personal Digital Assistants
- Notebooks and Handhelds
- Portable Instrumentation
- Digital Cameras
- Peripherals
- Audio Players
- Keypads, Side Keys, LCD Displays

Marking Information



9A = Device Marking Code
Bar indicates cathode

Equivalent Circuit and Pin Configuration

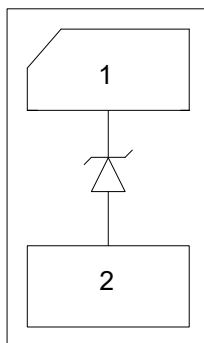

Circuit and Pin Schematic

Ordering Information

Part Number	Packaging	Reel Size
AU0571P6H	3000/Tape & Reel	7 inch

Absolute Maximum Ratings ($T_A=25^\circ\text{C}$ unless otherwise specified)

Parameter	Symbol	Value	Unit
Peak Pulse Power (8/20 μs)	Ppk	3520	W
Peak Pulse Current (8/20 μs)	Ipp	160	A
ESD per IEC 61000-4-2 (Air) ESD per IEC 61000-4-2 (Contact)	VESD	± 30 ± 30	kV
Operating Temperature Range	TJ	-55 to +125	$^\circ\text{C}$
Storage Temperature Range	Tstg	-55 to +150	$^\circ\text{C}$

Electrical Characteristics ($T_A=25^\circ\text{C}$ unless otherwise specified)

Parameter	Symbol	Min	Typ	Max	Unit	Test Condition
Reverse Working Voltage	VRWM			5	V	
Breakdown Voltage	VBR	6			V	IT = 1mA
Reverse Leakage Current	IR			0.5	μA	VRWM = 5V
Forward Voltage	VF			1.2	V	IF = 10mA
Clamping Voltage	VC			9	V	I _{PP} = 1A (8 x 20 μs pulse)
Clamping Voltage	VC			22	V	I _{PP} = 160A (8 x 20 μs pulse)
Junction Capacitance	CJ		1100		pF	VR = 0V, f = 1MHz

Typical Performance Characteristics ($T_A=25^\circ\text{C}$ unless otherwise Specified)

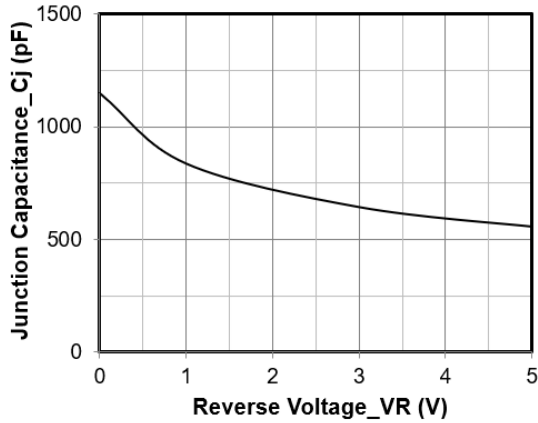

Junction Capacitance vs. Reverse Voltage

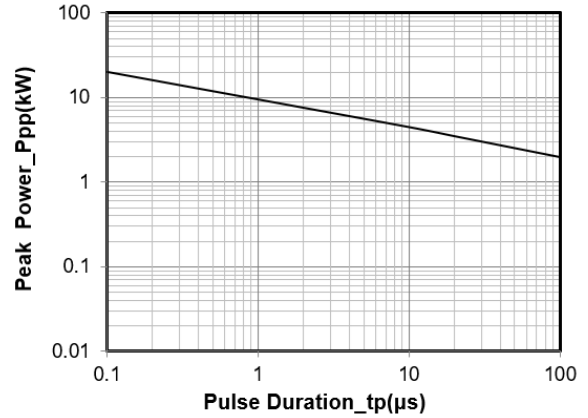

Peak Pulse Power vs. Pulse Time

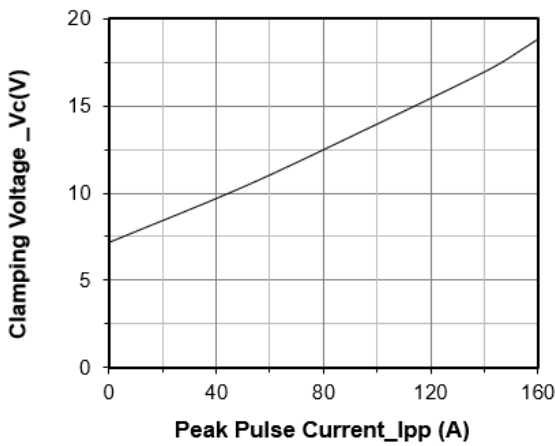

Clamping Voltage vs. Peak Pulse Current ($t_p = 8/20\mu\text{s}$)

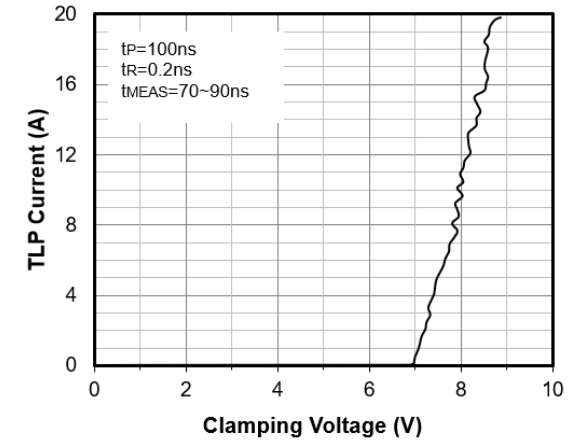

TLP Measurement

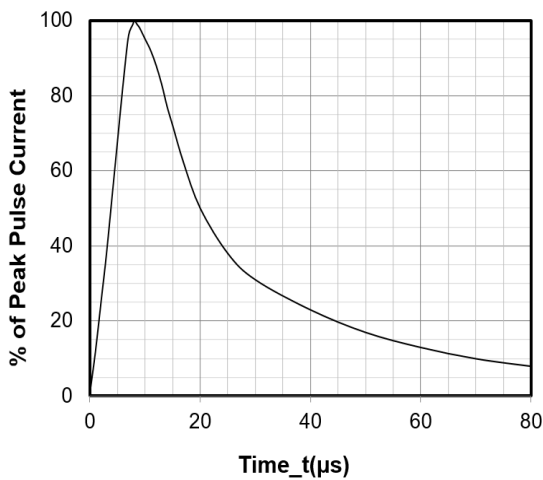

8 X 20μs Pulse Waveform

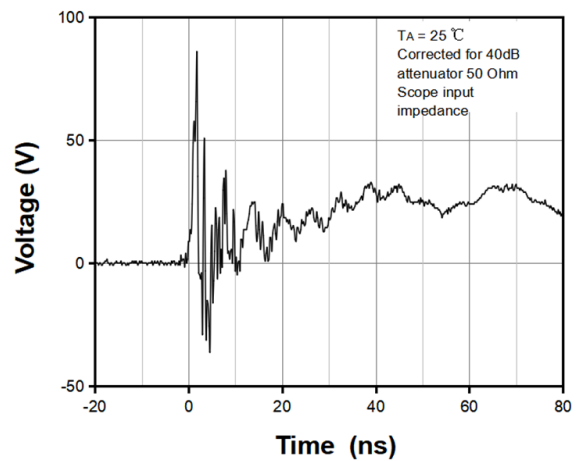

ESD Clamping Voltage
+8 kV Contact per IEC61000-4-2

DFN1610-2 Package Outline Drawing

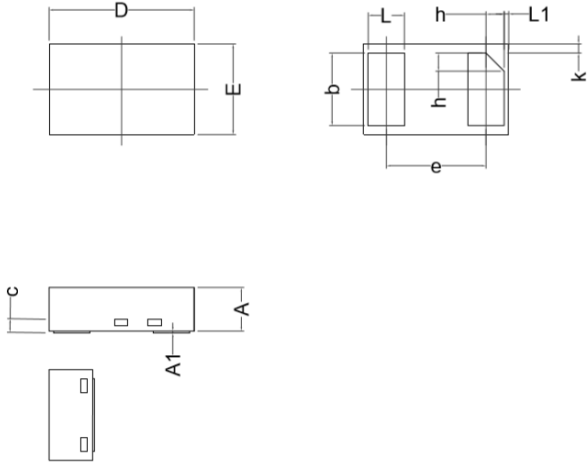

SYM	DIMENSIONS					
	MILLIMETERS			INCHES		
	MIN	NOM	MAX	MIN	NOM	MAX
A	0.45	0.50	0.55	0.018	0.020	0.022
A1	0.00	0.02	0.05	0.000	0.001	0.002
b	0.75	0.80	0.85	0.030	0.032	0.034
c	0.10	0.15	0.20	0.004	0.006	0.008
D	1.55	1.60	1.65	0.062	0.064	0.066
e	1.10 BSC			0.044 BSC		
E	0.95	1.00	1.05	0.038	0.040	0.042
L	0.35	0.40	0.45	0.014	0.016	0.018
h	0.15	0.20	0.25	0.006	0.008	0.010
k	0.05	0.10	0.15	0.002	0.004	0.006
L1	0.05 REF.			0.002 REF.		

Suggested Land Pattern

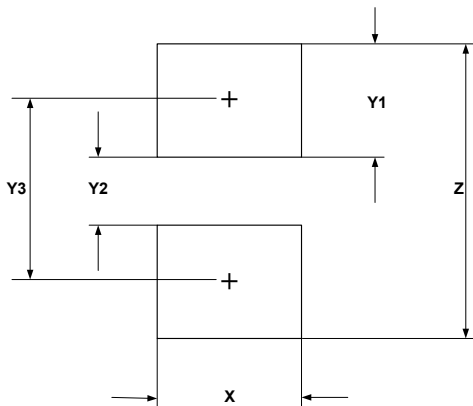

SYM	DIMENSIONS	
	MILLIMETERS	INCHES
X	1.00	0.040
Y1	0.62	0.025
Y2	0.60	0.024
Y3	1.22	0.049
Z	1.85	0.074